

SPEC ANY TECH. *Configure your fit.*

Cabinets

PRO Cabinets™ are stunning, architectural pedestals that integrate any tech combination for flush and surface mount devices into a single, beautiful presentation that brings tremendous curb appeal to any entryway. With their easy-to-customize form factor, full access back panel, heavy duty construction, and superior anchor plate, they are the preferred choice for security consultants and integrators around the world.

PRODUCT FEATURES

- Specify any access control device(s)
- Attractive, modern architectural design
- Heavy duty 304 stainless steel construction
- Standard 4" depth, Multiple widths available
- Removable "full access" back panel
- Internal .25" base plate, "no wobble" superior anchoring
- No visible fasteners after installation
- Easily customizable
- Free custom CAD designs in 24 hours
- Fast installation for installers
- Made in the USA



Areas of Use

- Multi-Tenant Units
- Premier Office & Lobby
- Gate Ingress/Egress

QUICK FEATURE COMPARISON

	Made from	Removable back panel	Top	Widths	Customization
CABINETS	Sheet metal	Full access	Flat	Unlimited 8"+	Unlimited & profile dimensions
BOLLARDS	Metal tubes	Small hand access	Flat or tapered	Limited 8" or less	Limited, dependent on tube mill dimensions

Models

Imagine your device cutout options

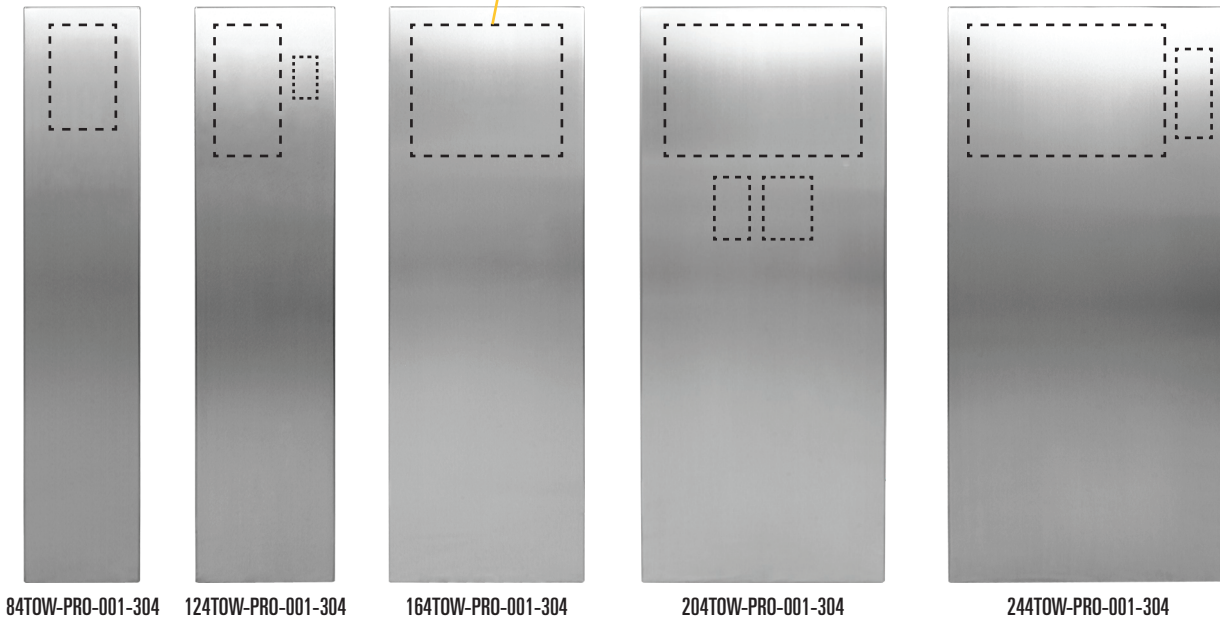

PRO TECH ACCESSORIES

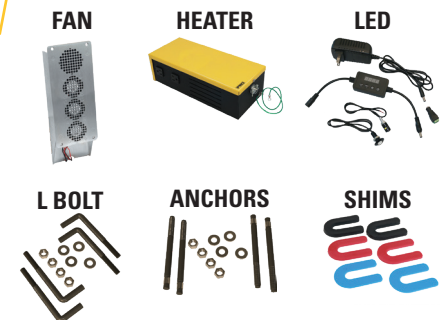

MATERIAL OPTIONS

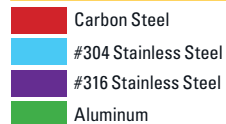

STAINLESS FINISH



POWDERCOAT FINISHES

STANDARD COLORS



READILY AVAILABLE METALLIC COLORS

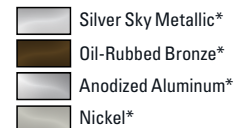

CUSTOM "RAL" COLORS AVAILABLE**

*short lead times and additional costs may apply
**additional costs and lead times apply

Technical Specs

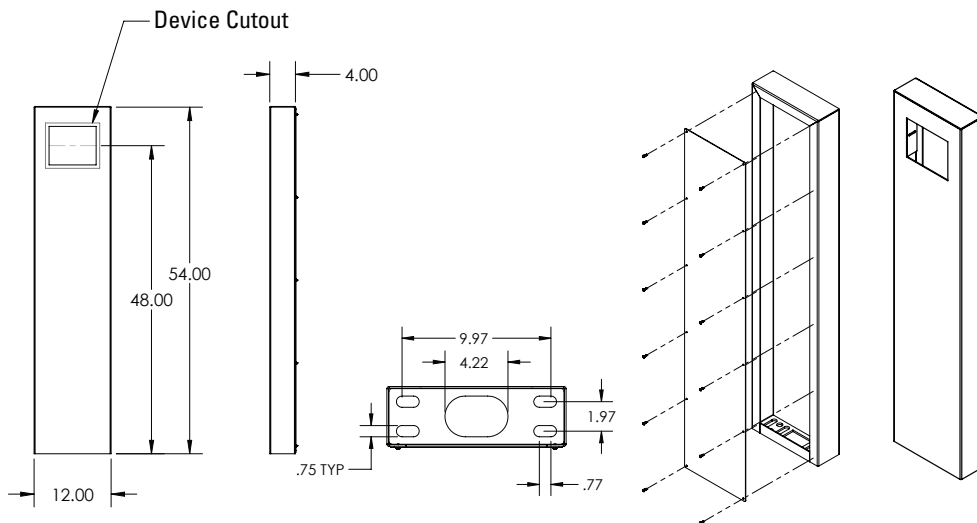

Cabinet Style Pedestals

Key Features

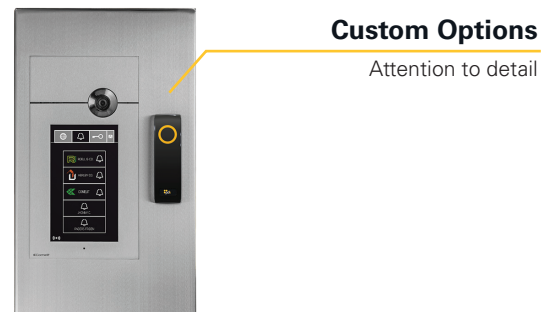
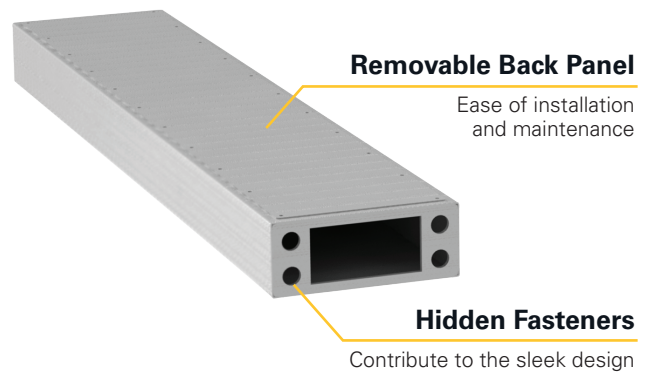

Part Numbers

FAST Foundations	Hgt	Wdth	Dpth	Wgt	Material	Description	Conduit Attachments	Pour/Application
66TOW-EMER-01-304	32"	32"	32"	108 lbs	304 SS	Prefabricated anchor	(2) 1/2-13 Tapped Holes	In-ground, gravel/dirt fill
66TOW-EMER-02-304	16"	15'	6"	22 lbs	304 SS	Prefabricated anchor	—	Wet concrete
L-Bolt-625	10"	—	—	12 lbs	Galvanized	L-Bolt Kit (.625" diam)	—	Wet concrete
Stud-Anchor-625	7"	—	—	12 lbs	Galvanized	Stud-Anchor Kit (.625" diam)	—	Existing concrete, retrofit

Wall Stations	Hgt	Wdth	Dpth	Wgt	Material	Description	Intercom Cutout Included	Application
156STA-EMER-01-ALU	36"	15"	6"	19 lbs	Alum	Wall Station - Generic	None (cutouts can be added)	Wall mount
156STA-AXIS-01-ALU	36"	15"	6"	19 lbs	Alum	Wall Station - Axis	(1) 2N IP Safety*	Wall mount
156STA-ZENI-01-ALU	36"	15"	6"	19 lbs	Alum	Wall Station - Zenitel	(1) TCIS 2**	Wall mount

*2N IP Safety requires plaster board mount P/N 9151002

**TCIS 2 or equivalent requires flush mount box P/N 107216008140

Cabinet Options

TECH INTEGRATION

Integrate intercoms, keypads, card readers, cameras and more from our vast device library representing over 35 OEM brands and 400+ devices. Our engineers are ready to incorporate your tech into our cabinets. We also offer in-house cooling fans, heaters, LED lighting, and weather shrouds solutions to meet all your tech integration needs.



FREE CUSTOM CAD

CAD engineers are free to use and on-call to create drawings specific to your project requirements. CAD designs are created within 24 hours.

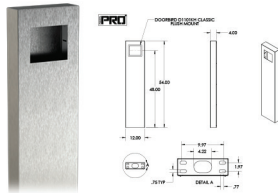

EXPEDITED FABRICATION

12 – 15 days	Standard, no additional charge
10 – 11 days	15% fee
8 – 9 days	25% fee
6 – 7 days	45% fee
4 – 5 days	65% fee
2 – 3 days	100% fee

Business days exclude weekends and holidays, does not include shipping costs or timelines.

Product Categories



EV Charging Stands



Emergency Call Towers



Custom Camera Mounts



Bollards



Cabinets



Goosenecks



Housings



Hoods



Accessories