

DATA SHEET

A dual height pedestal with one extension at 72" and the other at 42". Both extensions originate from a single vertical post making wiring easy. This pedestal can accommodate ADA-compliant specifications as well as car, SUV, and truck/bus applications. Contains conduit access through its baseplate for electrical wiring. It is bent at 90 degrees for a clean, professional look. It is finished off using a UV protected polyester black wrinkle powdercoat.

- ☑ Generally in stock
- ☑ Custom heights and colors available—request a price quote

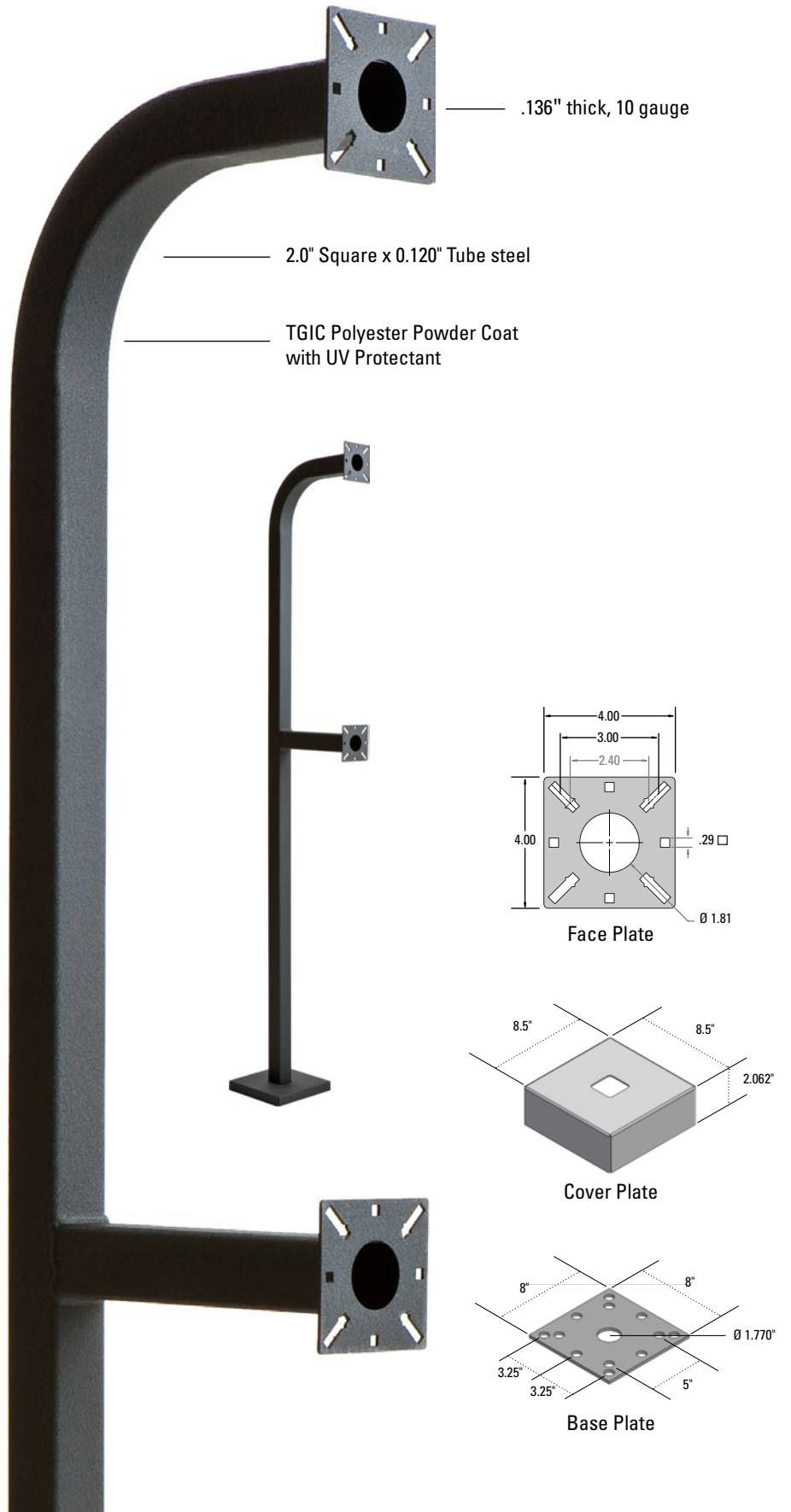
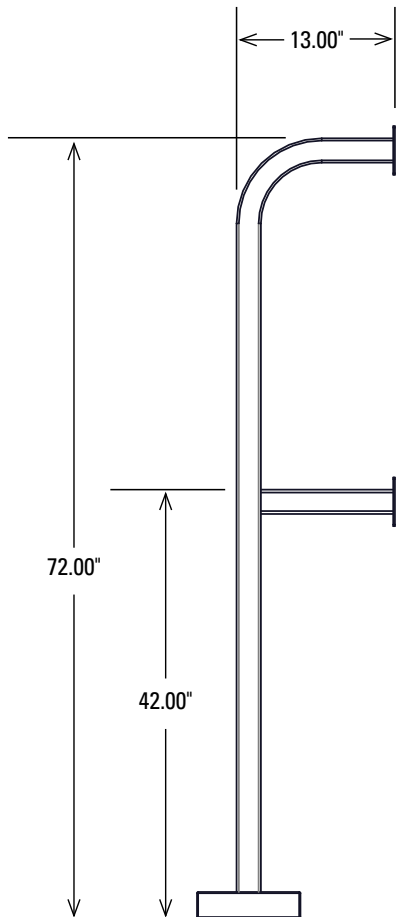

Stress Tests

Wind Speed	157 mph (Category 5 hurricane)
Wind Force	0.54 psi
Maximum Deflection or Displacement	0.207" at top edge
Maximum Stress	13,634.10 psi
Yield Strength	31,994.5 psi (strength at which the material bends permanently)

Interpretation: A "Category 5" hurricane wind begins at 157mph sustained. At this speed, the pedestal will flex slightly, allowing it to move about 0.207" at most. However, the stress encountered is not high enough to cause permanent bending. In the real world, the concrete or mounting bolts and nuts would fail first, not to mention the electronics would blow off even sooner.

Unique Features

Height:	72" & 42"
Finish:	Black Wrinkle TGIC Polyester Powdercoat — with UV Protectant
Faceplate:	4" x 4" Universal, .136" CRS (10 gauge)
Baseplate:	8" x 8" Universal, .25" CRS
Tube:	2" x 2" Square, .120" Wall (11 Gauge)
Neck:	13", 90° Bend
Material:	Heavy Gauge Steel
Box Size:	40 lbs - Box Size: 76 x 15 x 10
Hardware:	Included: Carriage Bolts & Nuts
Color Options	<input checked="" type="checkbox"/> <input type="checkbox"/> <input type="checkbox"/>
Customization Options	Custom heights and colors available

