

PRODUCT FEATURES

- Designed for security professionals
- Luxury aesthetics
- Antimicrobial surface
- Brushed #4 (180 grit)
- Universal design
- Heavy duty 14-gauge material
- Stainless steel construction
- Military-grade EPDM rubber seal
- #304 Stainless steel hinge
- 3" Backbox space
- 3" Weather/privacy shroud
- Removable door
- Cam lock included
- Knockouts on backside
- IP54 rating
- NDAA, Buy American, or USMCA/CUSMA compliant
- Build To Order (BTO)
- Available direct or through distribution

**CUSTOM OPTIONS**

- Factory cutouts available for your devices
- Shorten or extend height, width, or depth
- Readily available powder coating colors (white, yellow, bronze, gray, silver)
- Choose any RAL powder color
- Change material to #316 stainless

DESCRIPTION

A beautifully brushed stainless steel housing to combine one or more access control devices such as keypads, card readers, intercoms, and entry/exit buttons side by side. Mount on a wall or pedestal at a gate, lobby, or entryway. Outdoor rated with weather/privacy shroud, EPDM rubber seal, and stainless steel hinge. Convenient knockouts on the backside. Cam lock included. Door is removable.

RECOMMENDED ACCESSORIES**ROTATING HEAD**

OMNI-4W5T-BLK

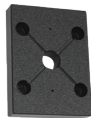
BUFFER PLATE

46PLA-PRO-001-HDP

HEATER

ACC-HEA-001-304

COOLING FAN

ACC-FAN-001-304

LIGHT KIT

ACC-LED-001

Model No. **Lando-SS-16x8-E**

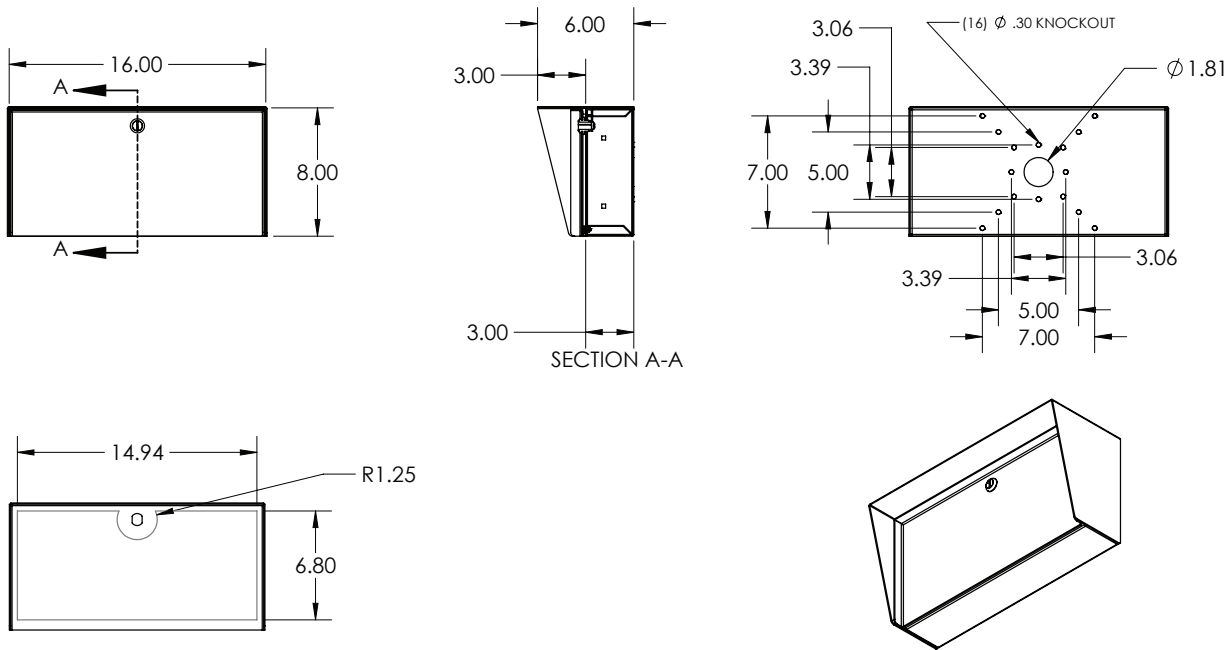

DATA & SPECS

Product Style	Housing
Material	#304 Stainless steel, .0749" (14 gauge)
Tube	#304 Stainless steel
Face Plate	EPDM rubber
Base Plate	IP54
Cover Plate	Yes
Mounting Method	Knockouts, qty 4+
Pretreatment	n/a
Finish	Brushed #4 (180 grit) with mirrored corner radiuses
UV Protection	n/a
Hardware	none
Packaging	Foam wrapped and boxed individually
Package Size	17 x 9 x 7
Weight	13 lbs
Shipping Method	UPS, FedEx, or LTL freight
Compliance	NDA, Buy American, or USMCA/CUSMA (see website for details)
Warranty	1 year limited (see website for details)
Inventory Status	Build To Order (Fast Track production is available)

SIMILAR PRODUCTS

