

NOTES:
 1. MATERIAL OF CONSTRUCTION IS 304 SS BRUSHED #4.

UNLESS OTHERWISE SPECIFIED:
 DIMENSIONS ARE IN INCHES
 TOLERANCES:
 FRACTIONAL $\pm 1/32$
 ANGULAR: $\pm 2^\circ$
 TWO PLACE DECIMAL ± 0.010
 THREE PLACE DECIMAL ± 0.005
 INTERPRET GEOMETRIC
 TOLERANCING PER:
 ASME Y14.5 -2009

NAME	DATE
DRAWN	
CHECKED	

TITLE:
INSTALLATION

SIZE A	PART NO. 610HOU-AWID-01-304	REV A
WEIGHT: 8.078	NO SCALE	SHEET 1 OF 6

ITEM NO.	PART NUMBER	DESCRIPTION	QTY.
1	610HOU-AWID-01-304 ENCLOSURE	ENCLOSURE WELDMENT	1
2	610HOU-AWID-01-304 HOOD	HOOD	1
3	610HOU-AWID-01-304 DOOR	DOOR WELDMENT	1
4	HINGE	PIANO HINGE	1
5	CAM LOCK	STRAIGHT CAM	1
6	GASKET SIDE	3/8" X .150 WEATHERSTRIPPING	2
7	GASKET TOP	3/8" X .150 WEATHERSTRIPPING	1
8	--	6-32 PAN HEAD SCREW	2
9	--	6-32 EXTERNAL TOOTH LOCK NUT	2

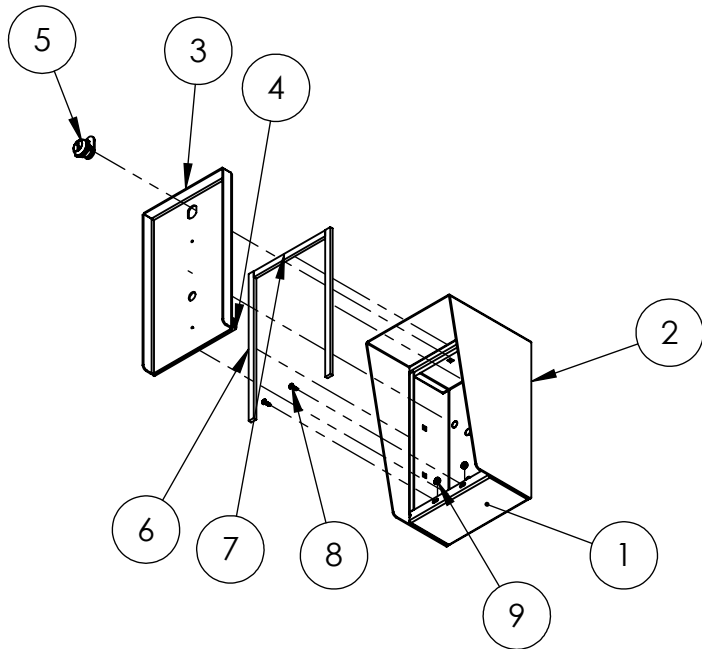

NOTES:

1. SEE STANDARD PREPARATION AND COATING INSTRUCTIONS FOR COATING PROCEDURE AND COLOR.
2. SEE STANDARD PACKAGING INSTRUCTIONS FOR PACKAGING PROCEDURE.

UNLESS OTHERWISE SPECIFIED:

DIMENSIONS ARE IN INCHES
TOLERANCES:
FRACTIONAL $\pm 1/32$
ANGULAR: $\pm 2^\circ$
TWO PLACE DECIMAL ± 0.010
THREE PLACE DECIMAL ± 0.005

INTERPRET GEOMETRIC
TOLERANCING PER:
ASME Y14.5 -2009

NAME	DATE
DRAWN	
CHECKED	

TITLE:

ASSEMBLY

SIZE A	PART NO. 610HOU-AWID-01-304	REV A
WEIGHT: 8.078	NO SCALE	SHEET 2 OF 6