

NOTES:
 1. MATERIAL OF CONSTRUCTION IS 304 SS, BRUSHED #4.

www.GooseneckStands.com

(888) 378 - 1045

Sales@GooseneckStands.com

UNLESS OTHERWISE SPECIFIED:

DIMENSIONS ARE IN INCHES
 TOLERANCES:
 FRACTIONAL $\pm 1/32$
 ANGULAR: $\pm 2^\circ$
 TWO PLACE DECIMAL ± 0.010
 THREE PLACE DECIMAL ± 0.005

INTERPRET GEOMETRIC
 TOLERANCING PER:
 ASME Y14.5 -2009

NAME DATE

DRAWN

CHECKED

PROPRIETARY AND CONFIDENTIAL

THE INFORMATION CONTAINED IN THIS
 DRAWING IS THE SOLE PROPERTY OF
 PEDESTALPRO LLC. ANY REPRODUCTION
 IN PART OR AS A WHOLE WITHOUT THE
 WRITTEN PERMISSION OF PEDESTALPRO LLC
 IS PROHIBITED.

TITLE:

INSTALLATION

Tuesday, October 23,
 2018 1:52:42 PM

WEIGHT: 56.699

SIZE
A

PART NO.
 84TOW-AIPH-02-304

REV
B

NO SCALE

SHEET 1 OF 7

ITEM NO.	PART NUMBER	DESCRIPTION	QTY.
1	84TOW-AIPH-02-304	TOWER WELDMENT	1
2	PLTCAP-84-84-30	CAP	1
3	PLTACC-510	ACCESS PANEL	1
4	PLTBAS-84-84	BASE PLATE	1
5	--	8-32 X 1/2" SS BUTTON HEAD SCREW	4

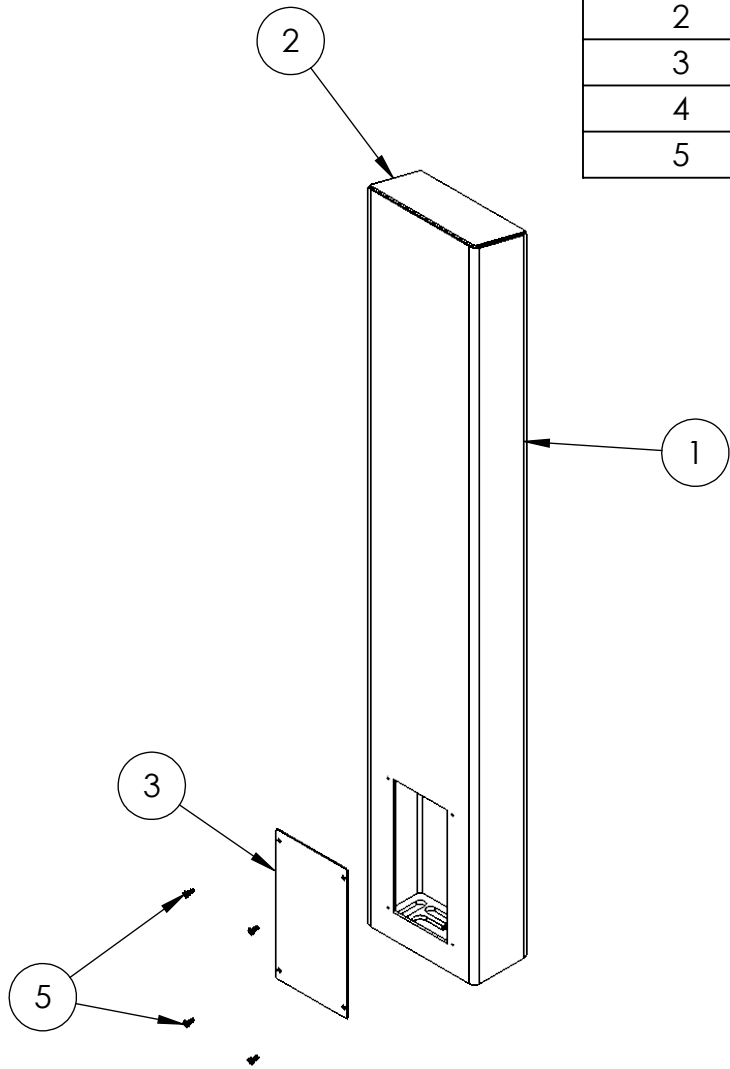

NOTES:

- SEE STANDARD PREPARATION AND COATING INSTRUCTIONS FOR COATING PROCEDURE AND COLOR.
- SEE STANDARD PACKAGING INSTRUCTIONS FOR PACKAGING PROCEDURE.

www.GooseneckStands.com (888) 378 - 1045 Sales@GooseneckStands.com	UNLESS OTHERWISE SPECIFIED:	NAME	DATE	TITLE:			
	DIMENSIONS ARE IN INCHES TOLERANCES: FRACTIONAL $\pm 1/32$ ANGULAR: $\pm 2^\circ$ TWO PLACE DECIMAL ± 0.010 THREE PLACE DECIMAL ± 0.005	DRAWN			ASSEMBLY	SIZE	PART NO.
INTERPRET GEOMETRIC TOLERANCING PER: ASME Y14.5 -2009	CHECKED			Tuesday, October 23, 2018 1:52:42 PM		A	84TOW-AIPH-02-304
PROPRIETARY AND CONFIDENTIAL THE INFORMATION CONTAINED IN THIS DRAWING IS THE SOLE PROPERTY OF PEDESTALPRO LLC. ANY REPRODUCTION IN PART OR AS A WHOLE WITHOUT THE WRITTEN PERMISSION OF PEDESTALPRO LLC IS PROHIBITED.				WEIGHT: 56.699	NO SCALE	SHEET 2 OF 7	